

Please check GSPN for parts update!

Version	Parts No	Short Description
HQ01	BN44-00364A	SMPS
HQ01	BN44-00382C	SMPS
HQ01	BN81-04720A	T-CON PCB
HQ01	BN94-03519A	Main PCB
HQ01	BN94-03564C	Misc Docking
HQ01	BN94-03610A	Misc Main PCB
HQ01	BN96-14064A	Touch Remote IR PCB
HQ01	BN96-14587A	Function Touch PCB
HQ01	BN96-14758A	ASSY Docking PCB A
HQ01	BN96-14759A	ASSY Docking PCB B
HQ01	BN96-15277A	Main PCB
HQ01	BN96-15640A	3D & IR PCB
HQ01	BN95-00398A	Panel
HQ01	BN96-15367A	Top Cover
HQ01	AK96-01194A	Dongle
HQ01	BN39-01341A	Lead Connector
HQ01	BN39-01344A	Lead Connector
HQ01	BN39-01369A	Lead Connector
HQ01	BN40-00162A	Tuner
HQ01	BN96-12068C	Speaker
HQ01	BN96-12845D	Power Cord
HQ01	BN96-13488A	USB Wireless
HQ01	BN96-13699A	Motor
HQ01	BN96-13901A	Speaker
HQ01	BN96-13902A	Speaker Rear
HQ01	BN96-14044A	USB Cable
HQ01	BN96-14108C	LVDS Cable
HQ01	BN96-14108D	LVDS Cable
HQ01	BN59-00802A	Remote Small
HQ01	BN63-06549A	Touch Remote Rear Cover
HQ01	BN96-14971A	Touch Remote Front Cover
HQ01	BN96-14972A	Touch Remote Middle Cover

FIRMWARE

Please check Samsung.com for latest update!

2010 LED Firmware for C9000 (T-VAL9AUSC, 1012.0)

■ Firmware for C9000

-Version : 1012.0 Folder Name: T-VAL9AUSC

- Related Models LED : UN46C9000ZF, UN55C9000ZF

- Description: Support Netflix 2.1 and MLB.tv apps.

Add "3D Optimize" option on Menu for better 3D image.

And this firmware prevents below issues:

USB 'Power Overload' message pops up even USB port is not connected

HDMI ports recognition error and signal loose

Plug & Play is displayed whenever turning on TV.

Service Bulletins

None: As of 9/2/11

HOT TIPS

Power On Problems: (see page 3)

Video Problems: (see page 4)

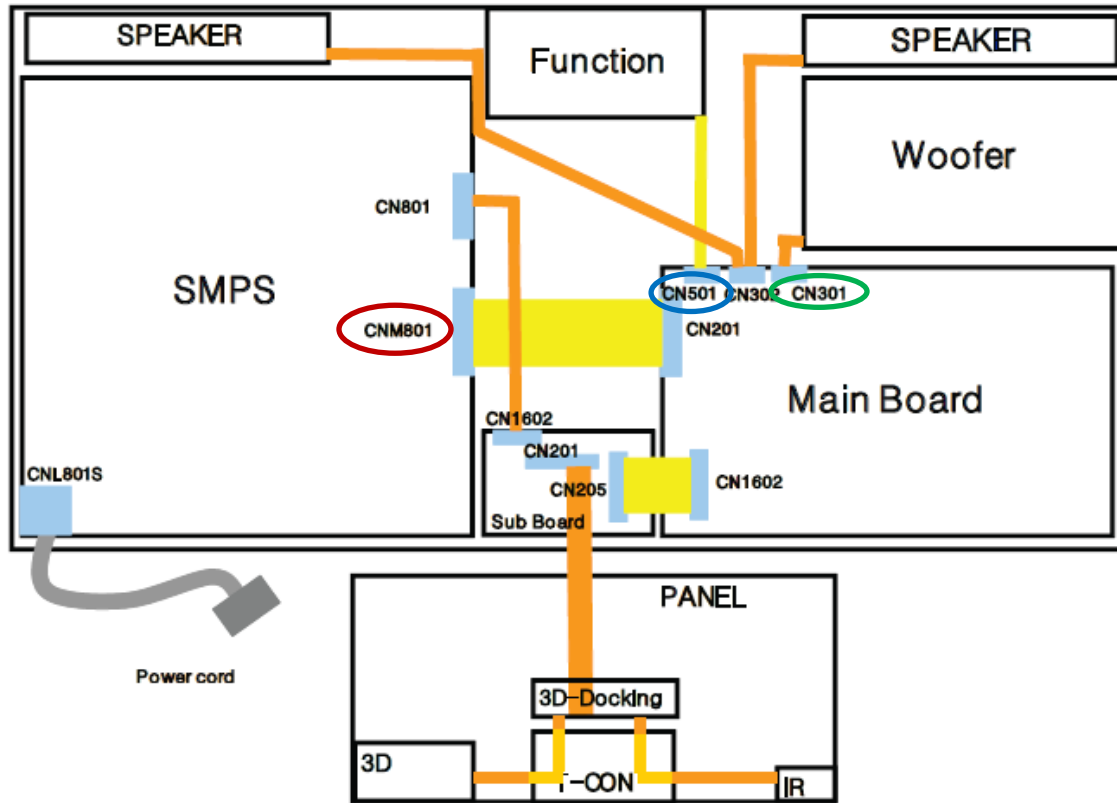

CNM801 (SMPS)

1	Top_Dim	11	GND	21	BLU_On/Off
2	Bot_Dim	12	GND	22	Power_On/Off
3	D12V	13	GND	23	OD_On/Off
4	D12V	14	GND	24	STBY
5	D12V	15	GND	25	GND
6	D12V	16	GND	26	GND
7	D12V	17	D5.3V	27	GND
8	D12V	18	D5.3V	28	GND
9	GND	19	D5.3V	29	Vamp
10	GND	20	D5.3V	30	Vamp

CN301(to Woofer)

1	SW+	5	SW+
2	SW-	6	SW-
3	SW+	7	SW+
4	SW-	8	SW-

CN501 (to Function)

1	A5V
2	A5V
3	KEY_INPUT1
4	KEY_INPUT2
5	GND
6	S_FUNCTION_CTRL

Power On Sequence:

1. Standby Voltage, (CNM801, #24, 5v)
2. Power On, (CNM801,#22, 0-1.2v)
3. Low Voltage Supplies On, (D12, D5.3V)
4. High Voltage Supplies On, (CNM801, #21, BLU_ON)
5. Back Light "On" Confirmation

To Force Backlight "On":

1. Remove Power Cord
2. Disconnect CN201 at Main Board
3. Short P_On to STBY (CNM801, #22 & 24)
4. Plug Power Cord In.
5. Backlight should now come on.

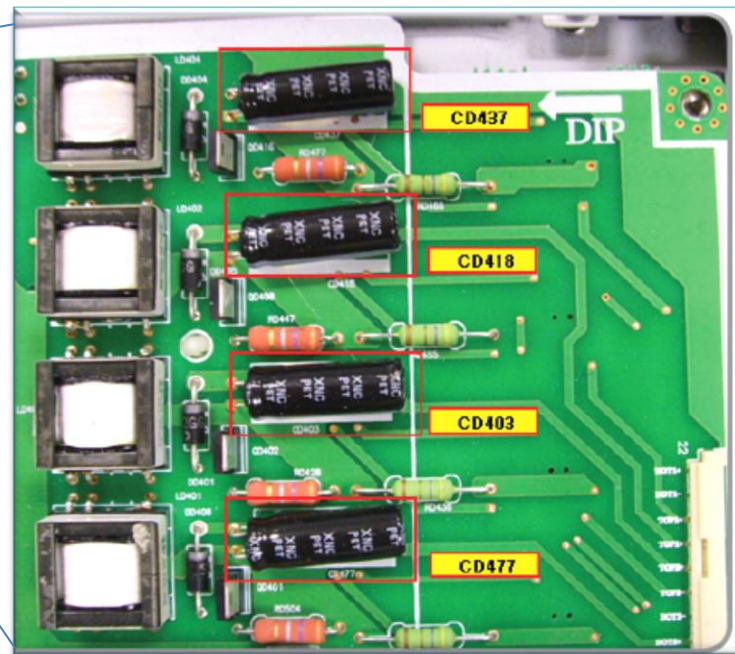
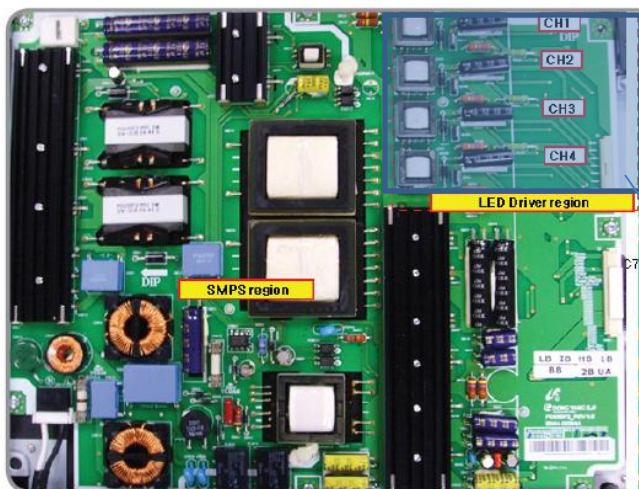

	CD437	CD418	CD403	CD477
46"	150VDC ~ 170VDC Panel or SMPS			
	179VDC ~ 256VDC Normal			
55"	340VDC ~ 380VDC Panel (LED bar problem)			
	150VDC ~ 170VDC Panel or SMPS			
	224VDC ~ 284VDC Normal			
	340VDC ~ 380VDC Panel (LED bar problem)			

TROUBLESHOOTING VIDEO PROBLEMS

1. Verify Video Operation

- Customer Picture Test (models available)
- “Display” (If display is OK source is suspected)
- Substitute with known good Source (external DVD or Signal Generator)

2. Using Test Patterns in Service Mode

- ENTER SERVICE MODE -

Select an active source signal. (HDMI preferred)
Test Pattern may rely on signal source to appear.

Using: Customer Remote	Service Remote
a. Power off	a. Power On
b. Mute, 1, 8, 2, Power	b. Info, Factory

2010 Models

LCD Signal Path for Troubleshooting

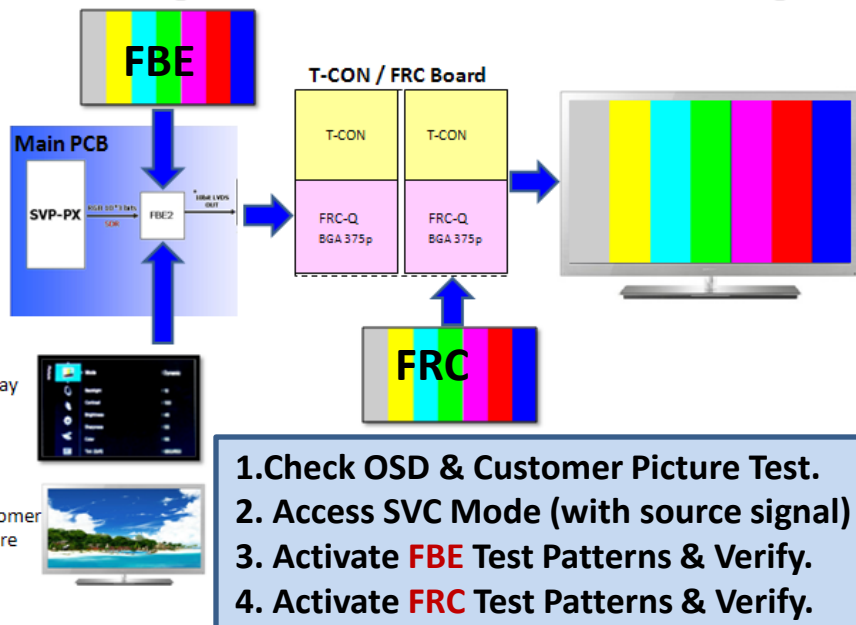

2011 LED 8000 Series

Verify Test Mode Signals

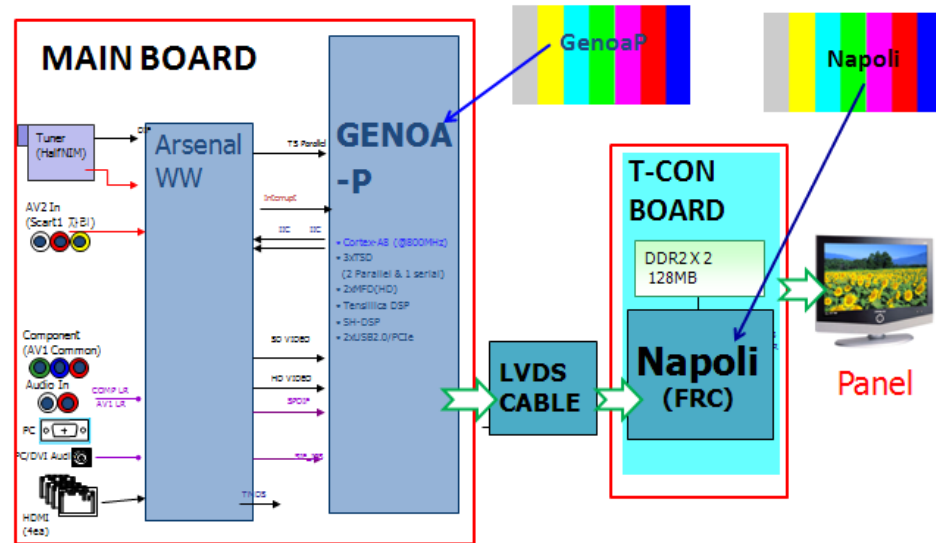

1. Select an active source signal. (HDMI preferred)
Test Pattern may rely on signal source to appear.
2. Access Service Mode
3. Access **SVC**
4. Access **Test Patterns**
5. Access **Genoa-P**
6. Check Test Patterns
7. If OK suspect input Source
8. Access **Napoli**
9. Check Test Patterns
10. If OK and Genoa-P was not good
Suspect Main Board or LVDS Cable



ON SCREEN FAILURE EXAMPLES:

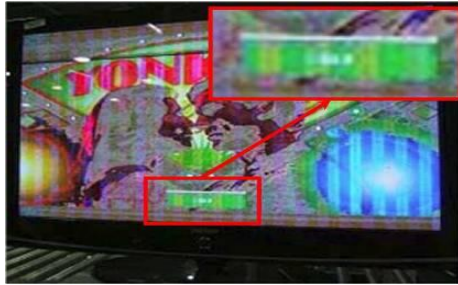

If Picture & Display errors
Defective Main Board, LVDS,
or T-CON

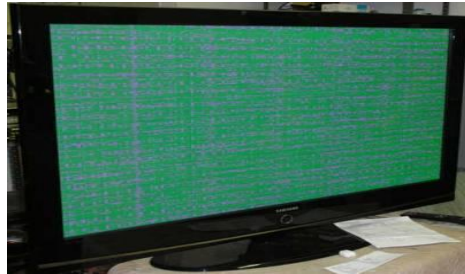

Green lines or a green screen
defective main board , LVDS ,
or T-CON.

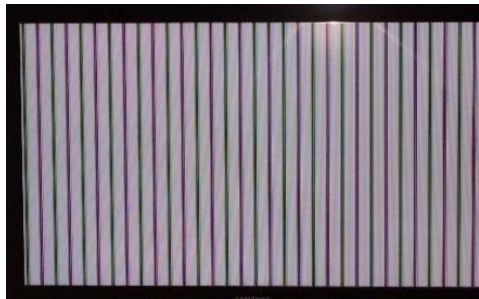

De-lamination: PANEL
FAILURE



Vertical or Horizontal Lines :Defective
Panel likely but also T-CON, LVDS, or
Main Board. Use Test Patterns in
Factory Service Mode to determine
error)

ALIGNMENTS:

1. Check/Set Option Bytes:

Model Code	Version
UN46C9000ZFXZA	HQ01

Option					
Type	Model	Tuner	Light Effect	Country	Front Color
46A2UF9E	UC9000	SEMCO	OFF	SAMEX	W-M-Whit

2. Check/Perform Firmware Upgrade for all repairs.

3. Perform reset in Service Mode & Plug and Play if Main board is replaced.

SPECIAL NOTES:

Inform customer of reset of all Settings if Main Board or Panel is replaced.